

# A NOVEL TECHNIQUE FOR ENHANCING THE HEALTH OF TRANSFORMER MINERAL OIL USING AI-BASED STRATEGY

Akshay sharma, Vinod Kumar

E-Mail Id: sharmakshay9876@gmail.com

Department of Electrical Engineering

College of Technology & Engineering, Udaipur, Rajasthan, India

**Abstract-** The power system operational reliability depends on the proper functioning of transformers. The decreased quality of mineral oil deteriorates the insulation of the transformer results in the failure of the transformer. Thus, maintaining the quality of the mineral oil is a severe issue for power utilities. The major cause of mineral oil deterioration is the formation of oxidative products due to the over-temperature and overloading conditions. This research paper presents an artificial intelligence-based strategy for the reduction of oxidative products by regulating the temperature level accordingly. During the various critical operating conditions, the temperature sensor measures the temperature of mineral oil. The neural network is trained to recognise the various abnormal events according to increased temperature level.

**Keywords:** Mineral oil, oxidative products, sludge, artificial intelligence, over-temperature.

## 1. INTRODUCTION

Power transformer, as one of the most important apparatus in power system, must be protected against failures as the effects of failures in terms of loss of revenue; outage time and cost of financing repairs are critical in modern power systems and have serious effects on operational performance. Failures of power transformer have a serious impact on the reliability and operational stability of the electric power system. The transformer operational reliability mainly depends on the dielectric strength of the insulation. The mineral oils are used as the insulating medium in the transformer. The reduced quality of mineral oil lessens the insulation strength results in transformer failure. Many factors may have an impact on the life of the transformer, e.g. surrounding weather conditions. Also, gradual insulation ageing (of paper and winding insulation) caused by thermal effects in transformers is one of the significant factors which harm operation stability [1-3].

The transformer faces various abnormal conditions during the operation such as single-phase to ground faults, the line to line faults, overvoltage, over-current, uneven power electronic loading that increases the temperature. This increased temperature increases the formation of oxidative products results in acids and sludge. The increased quantity of sludge stops the heat dissipation within the transformer results in transformer failure. To maintain the transformer long and worry-free service life various diagnostic tests are carried out. The transformer can lead to early ageing due to over-temperature and mechanical stresses faced by transformers during the common energization process. Although insulation system ageing is an unavoidable process, exposure of transformer to excessive levels of the above-mentioned ageing contributors results in accelerated ageing.

One of the most severe issues is the formation of oxidative products due to moisture contamination. The oxidative products start the formation of acids and sludge gradually. The rate of formation of oxidative products mainly depends on the temperature; an increase of 10°C generally doubles the rate of oxidation. The sludge forms a blanket barrier to the flow of heat from the oil to the coolant and from the core and coils to the cool oil. The sludge may even block off the flow of oil through the cooling ducts. As a result, the transformer insulation gets too hot and is damaged, particularly between turns of the windings [4-8]

Natural ester insulating oils (NEI) oils are environmentally friendly, but they have some disadvantages like low pour point, less oxidation stability, less resistance to lightning impulse, and high kinematic viscosity. Thus, more efforts are needed to overcome the limitations of NEI oils, including the addition of additives, modification of the chemical structure of oils and altering the transformer design to ensure compatibility with the oils. Various methods were proposed to improve the workability of NEI oils in power transformers [9- 10].

Method for calculating an accurate period of oil replacement and transformer lifetime was developed using the mathematical Simulink model. The study of the formation of furan quantity and insulation strength concerning time was done. The investigation on the failure rate of solid and liquid insulation, under the occurrence of different abnormal conditions faced by the transformers, was done. A neuro-fuzzy method for estimating the transformer life was developed based on the analysis of interfacial tension number, furan content in oil and the moisture content within the cellulose insulation was investigated. Regeneration of the aged transformer oil, by dealing with the activated carbon which is obtained from the agricultural wastes, was done. Various properties like breakdown strength, viscosity, and flash point were studied. Results proved that the activated carbon and antioxidants improve the quality of transformer oil for reuse [11-15].

DP is a widely accepted measurement that examines the health state of the insulating paper inside the transformers. Moreover, the viscometry method that used to measure DP is not a definite accurate method because it is affected

by the surrounding temperature Several authors developed methods for detecting the temperature of various locations of transformer such as hot spot temperature, temperatures at insulations, winding duct oil temperature and average winding temperature. Different online techniques are proposed and developed for the measurement of the temperature level of the transformer. A very few researches are available which presents the methods for reducing the formation of oxidative products [16-18].

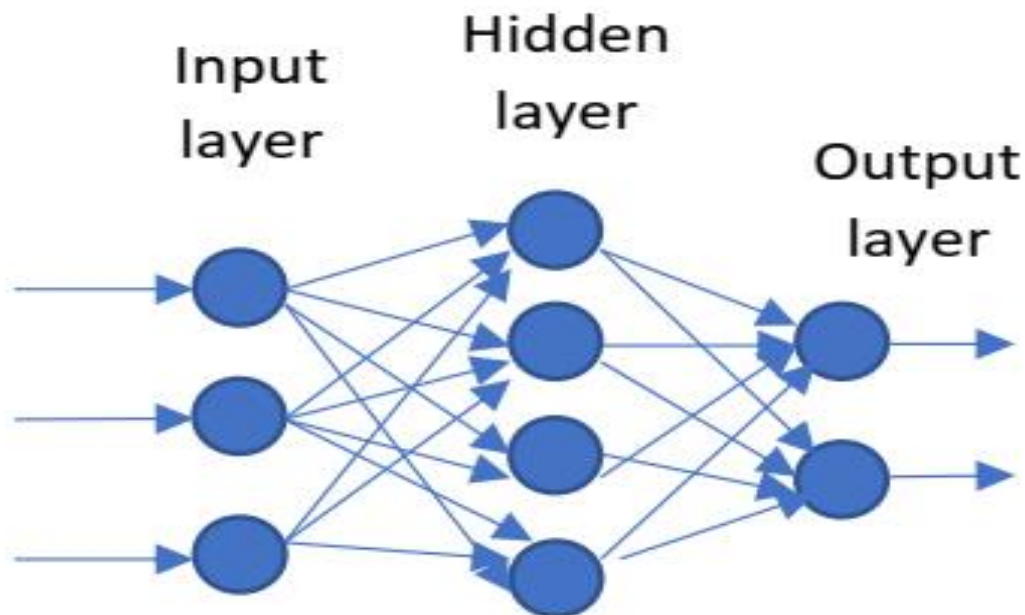
Most of the earlier publications discuss different types of transformer oil and factors resulting in deterioration. Several researchers suggested new and advanced type of oil to beat the disadvantages of mineral oil. The increased quantity of oxidative products is very harmful to transformer mineral oil. Some of the researchers developed a technique for detecting temperature at various transformer locations during abnormal events. Various online and offline methods are presented for the reuse of mineral oil. Although, there is a very publication are available to reduce the formation of oxidative products. Thus, there is an urgent need for an intelligent technique to lessen the oxidative products and sludge [1-18].

In additions, to the author's best knowledge, the earlier publications did not discuss any intelligent or novel technique which lessens the formation of oxidative products. In this paper, an artificial intelligence-based technique is developed for regulating the temperature level of the transformer accordingly under various abnormal conditions. As the increased temperature is a critical issue that raises the formation of oxidative product and sludge so it is important to regulate the temperature level of the transformer. The feed-forward neural network is trained to identify the various loading conditions causing increased temperature& accordingly containing the oxidative product formation. This developed novel strategy is the latest over previously presented researches that limit oxidative products by maintaining the temperature in assured specified limits.

This paper is structured as follows. Section I presents, the artificial intelligence-based methodology. Section II discusses the various results obtained during the investigation and the last is section III, which depicts the conclusions.

## 2. NEURAL NETWORK-BASED TECHNIQUE FOR TEMPERATURE REGULATION

The artificial neural network is applied for regulation of temperature due to its better quality of inevitability and suppleness over conventional methods. The NN based technique predicts the approaching thermal events with the present and past events. Moreover, the iterative training process is proposed to adapt itself to the upcoming events inside or outside the oil tank. The basic scheme of feed-forward neural network is depicted in Fig. 2.1.



**Fig. 2.1 Basic Scheme of Feed-Forward Neural Network**

The NN controller is trained to regulate the temperature in case of different abnormal events such as inductive switching, capacitive switching, uneven electronic loading, switching transients and various fault conditions. Many temperature ranges are employed in the training procedure. The procedure of neural network training is depicted in Fig. 2.2 by which temperature is regulated. The process mainly includes the following steps;

- Data collection of present and past temperature conditions like the inner and outer temperature of various transformer locations during the different critical events. The obtained temperature ranges are employed as input variables.
- Calculation of temperature for unexpected events based on ANN models to make the system better adaptable.
- System implements an optimal technique to regulating the temperature by increasing the fan speed.

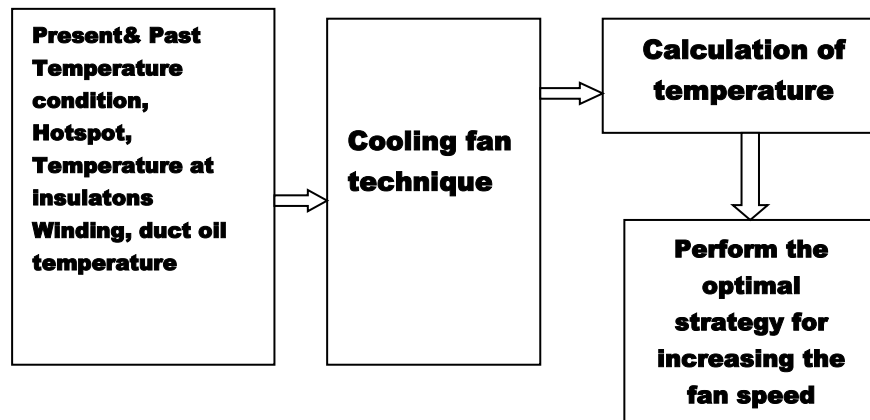


Fig. 2.2 Neural Network Procedure for Temperature Control

### 3. TEMPERATURE CONTROL LOGIC

A variety of temperatures of the inner and outer sides of the transformer, based on present and past conditions are shown in Table 3.1.

Table-3.1 Temperature Category

% of Increase in Temperature	Temperature category	Level of oxidation
Up to 10	Normal	Slow
11-20	Medium	Intensive
21-40	High	Highly intensive
More than 40	Very High	Very highly intensive

Table 3.2 illustrates the suitable quantity of oxidative product based on the quality of oil, which ranges from bad to excellent.

Table-3.2 Content of Oxidative Product

Content of Oxidative Product (ppm)	Oil Quality
10-15	Excellent
15-18	Good
18-22	Marginal
22-25	Bad
25-28	Very Bad
28-30	Extremely bad
>30	High Risk

## 4. RESULTS AND DISCUSSION

The transformer faces various abnormal events during its operation such as switching, uneven electronic loading and different fault conditions. Such events increase the temperature of the transformer; investigation on transformer oil is done under these conditions. The results are investigated, simulated & discussed in the following sections

### 4.1 Different Abnormal Events Occurred During the Operation

#### 4.1.1 Increased Power Electronic Loading

Uneven or increased electronic loading during the operation results in harmonics that cause additional losses and temperature rise of transformer oil. Also causes resonances between the transformer inductance and system capacitance and mechanical stress of winding and lamination. The voltage and current waveforms with varying

DOI Number: <https://doi.org/10.30780/IJTRS.V07.I03.002>

pg. 18

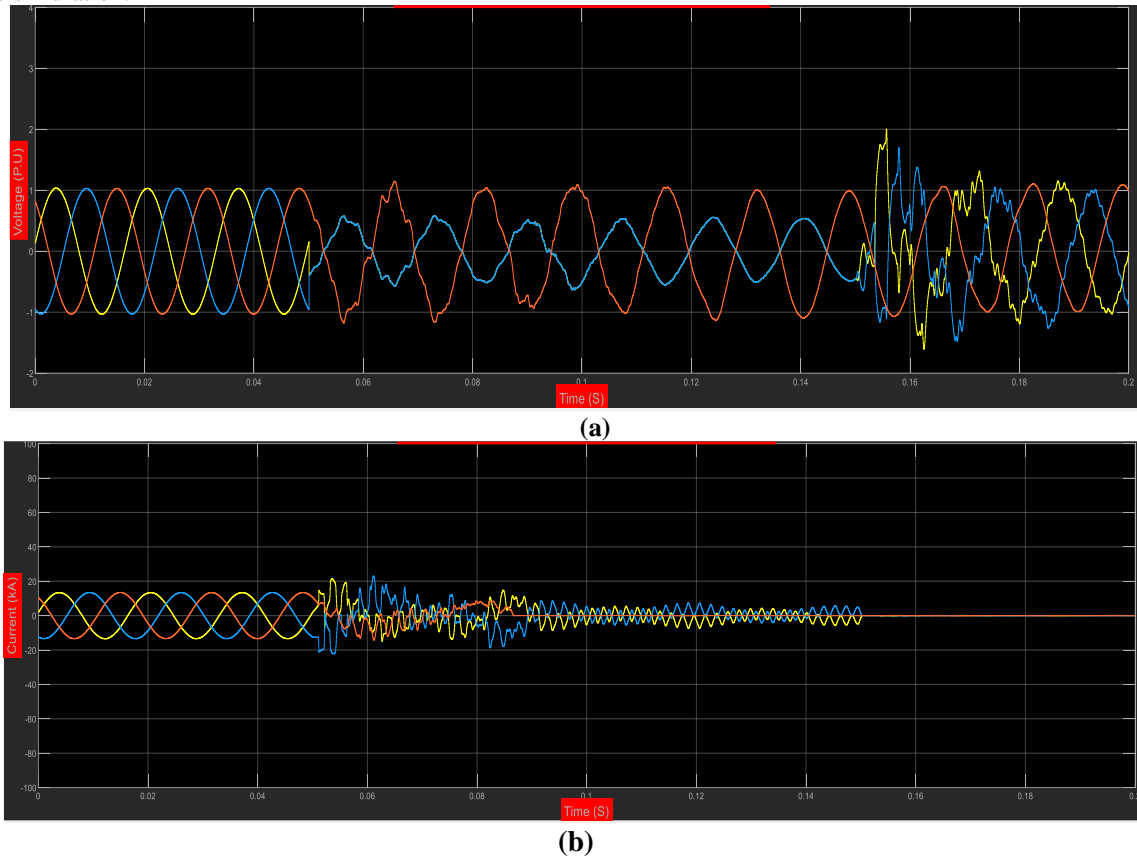
www.ijtrs.com, www.ijtrs.org

Paper Id: IJTRS-V7-I03-004

Volume VII Issue III, March 2022

@2017, IJTRS All Right Reserved

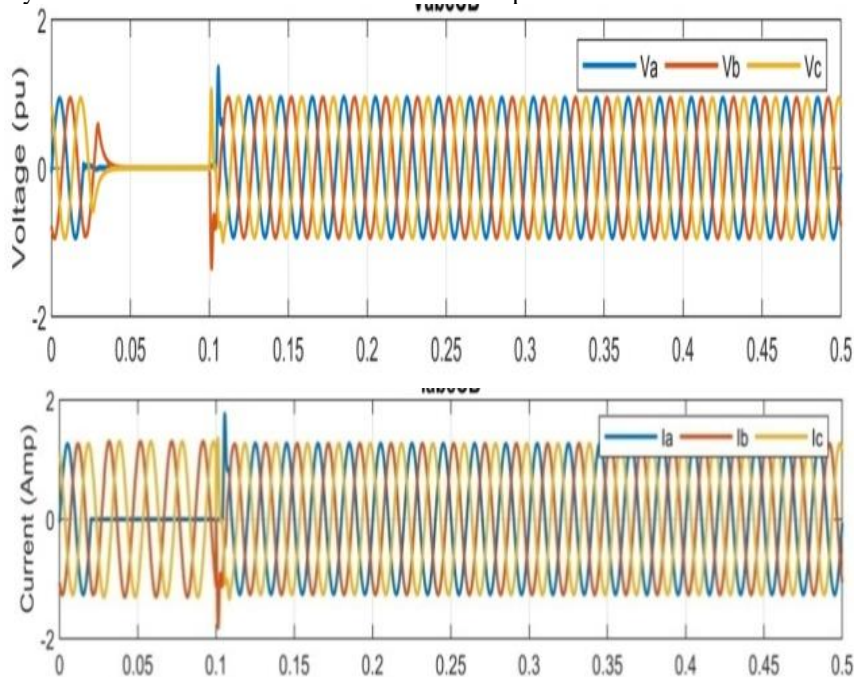
degrees of power electronic loading are illustrated in Fig. 4.1. The maximum power electronic loading is 35% in the simulation.



**Fig. 4.1 (a), (b) Voltage and Current Waveforms Respectively during Power Electronic Loading**

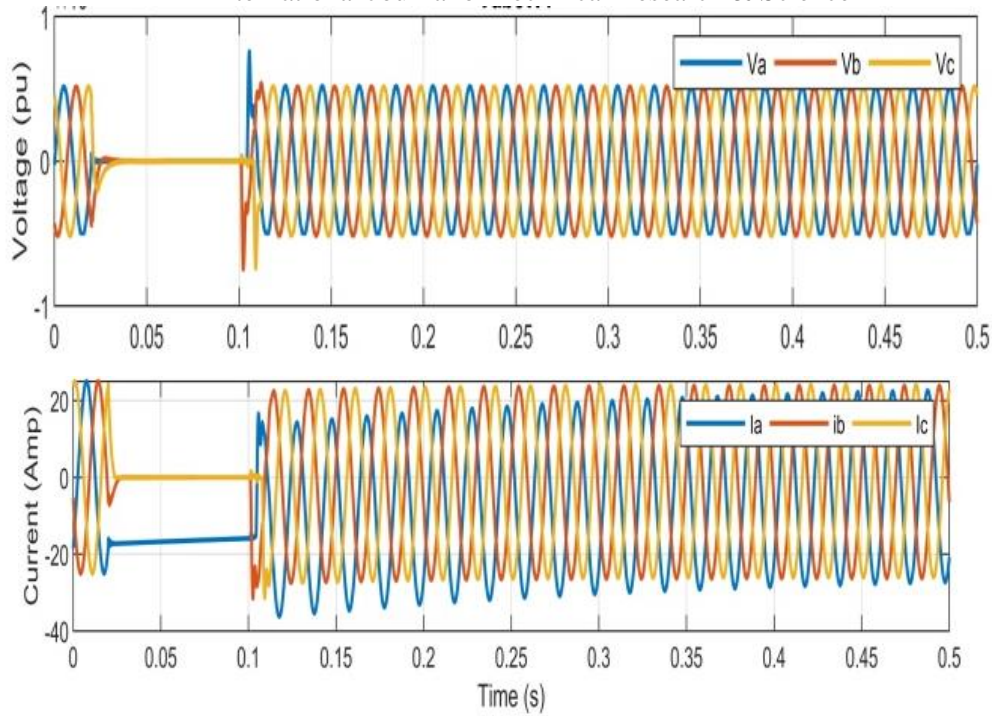
#### 4.1.2 Occurrence of Single-Phase Fault

The response of fictitious voltage and the currents of transformer during the fault period are shown in Fig. 4.2 to determine the performance/reliability of the transformer. During the single-phase fault, the transformer oil starts to heat and this increased heating of oil results in insulation degradation. There is a need to limit this temperature rise of the insulation system to overcome the formation of oxidative products.



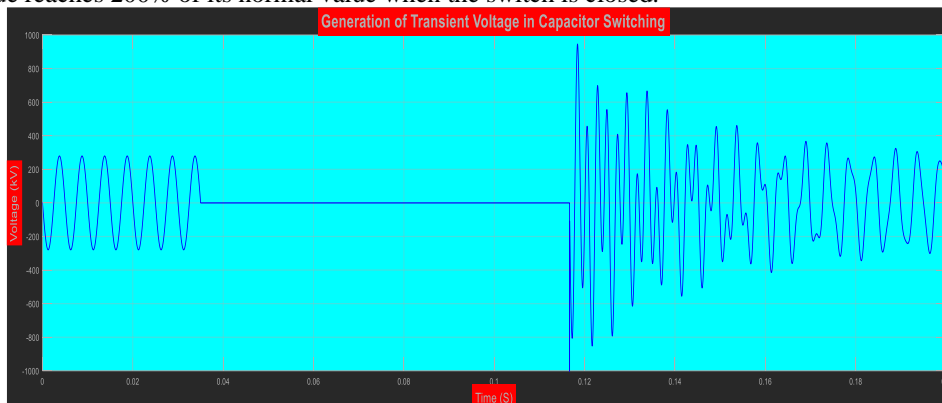
**Fig. 4.2 Voltage and Current Waveform Respectively During the Single-Phase Fault**

The response of fictitious voltage and the currents of the transformer during the three-phase fault period are shown in Fig. 4.2. The three-phase fault is the most severe fault in the power system which increases the temperature of transformer oil and deteriorates the insulation.

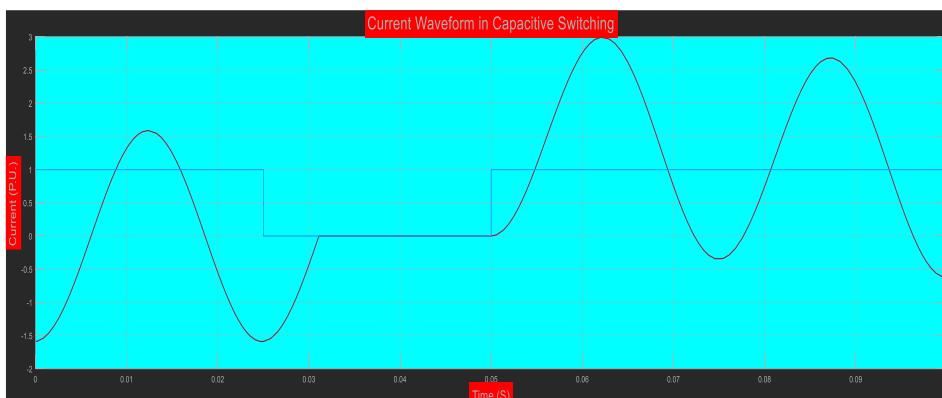


**Fig. 4.3 Voltage and Current Waveform Respectively during the Three Phase fault d.) Capacitive Switching Events**

Fig. 4.4 and Fig. 4.5 show the transient disturbance of the 3-phase voltage and current waveforms of all 3 phases. As the transient is characterized by a surge of current having a high magnitude and a frequency as high as several hundred Hertz, it can be noticed from the results that the voltage reaches 60% of its normal per-unit value and the current value reaches 200% of its normal value when the switch is closed.



**Fig. 4.4 Generation of Transient Voltage in Capacitor Switching in one Phase**

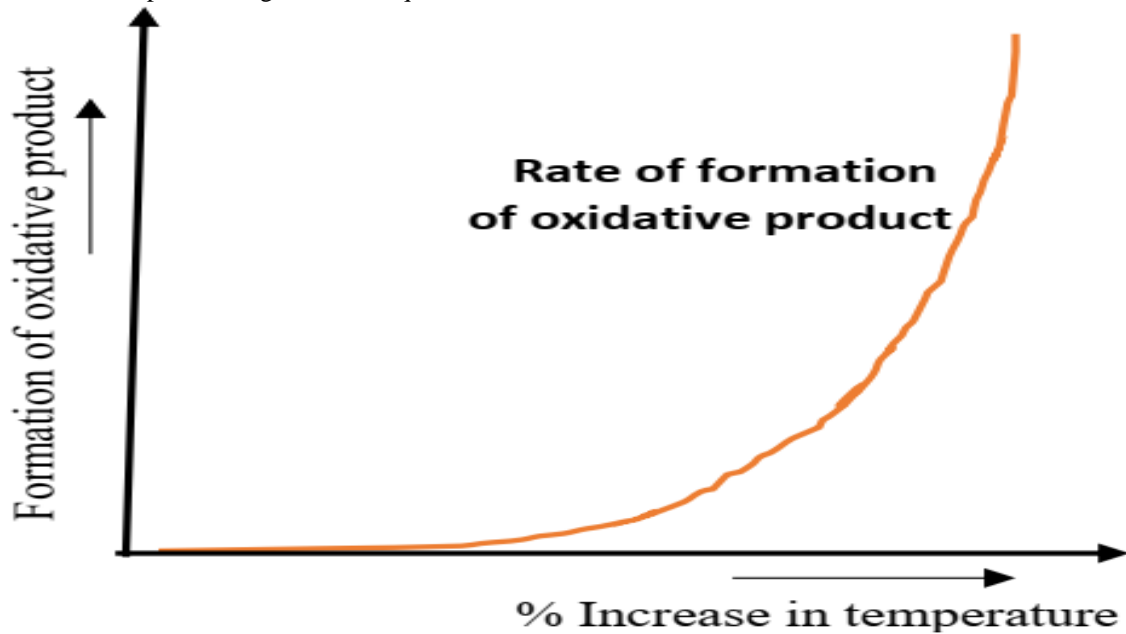


**Fig. 4.5 Current Waveform in Capacitive Switching in One Phase**

#### 4.2 Investigation on Oxidative Product Formation

The study on the formation of oxidative product concerning time is done at various temperature ranges during the operation. Many samples of mass gain of oxidative products are taken. The study reveals that when the increasing temperature is below 10 % from the rated temperature, the rate of oxidation stays constant with time, and the mass gain per surface unit with time follows a linear path as shown in Fig. 4.6. In this case, temperature regulation is not

required. In another case, if there is an increase in temperature is between 11-30%, the rate of oxidation increases rapidly. The mass gain per surface with time is close to a parabolic high, almost double as shown in Fig. 4.6. In this situation, the temperature regulation is required.



**Fig. 4.6 Formation of Oxidative Product with Temperature**

In the third category, if the increase in temperature is between 31-50%, the mass gain versus time shows a high increasing parabolic relationship. When the increase in temperature go beyond more than 50%, then oxidation takes place at an extremely high rate results in acids and sludge formation. By investigating the mass grain curves, the four crucial temperatures are identified at various oxidation temperatures.

Table 4.1 demonstrates the study of oil with different temperature conditions in terms of the mass of the oxidative content and breakdown voltage. After analysing data, we can say with increasing temperature the quantity of oxidative product rises rapidly, and the formation of sludge also begins. Another side the breakdown voltage is decreasing drastically which shows a regular deterioration of the oil.

**Table-4.1 Mass of Oxidative Content with Increase in Temperature**

S. No	Increase in temperature	Mass of oxidative content in oil (ppm)
1.	2%	11
2.	3%	13.2
3.	5%	16.6
4.	8%	18.9
5.	10%	20.3
6.	15%	24.8
7.	30%	29.1
8.	50%	35.88
9.	60%	41.95
10.	80%	48.2

In the proposed ANN-based temperature regulation method, the speed of cooling fans is regulated with the help of a power electronic converter whose results are depicted in Fig. 4.7 and 4.8. The results with the proposed technique are presented in Fig. 4.7, which shows that the oxidation rate is increasing very slow or almost constant. Results of breakdown voltage measurement during various temperature conditions are presented in Fig. 4.8 which depicts a slow decrease in breakdown strength compare to the traditional method.

The formation of oxidative products under regulated temperature with the help of the neural network technique is presented in Fig. 4.9. It can be seen that the rate of acid formation is slow in contrast to the traditional method.

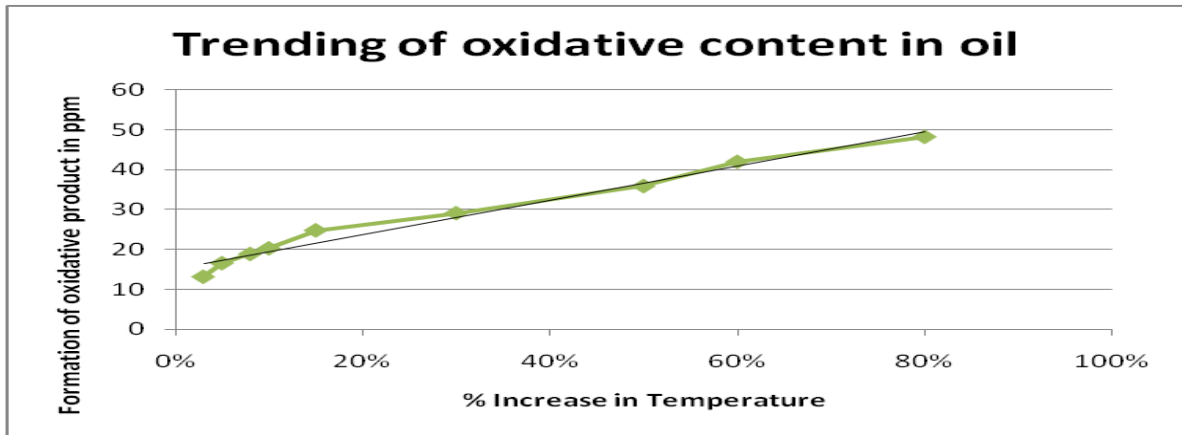


Fig. 4.7 Formation of Oxidative Content with Traditional Method

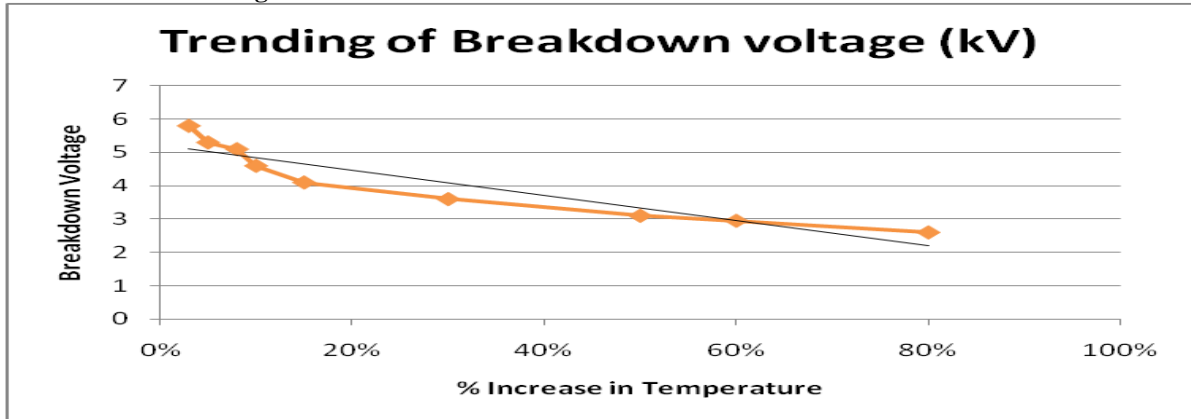


Fig. 4.8 Breakdown Voltage of Oil with Traditional Method

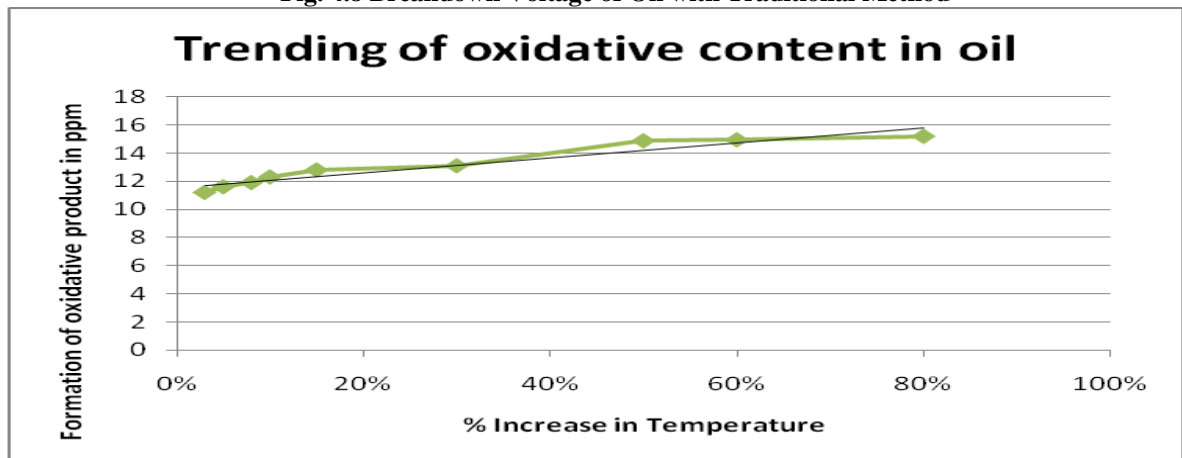


Fig. 4.9 Formation of Oxidative Product Content with Intelligent Technique

It can be seen in Fig. 4.10 that the results of breakdown voltage during the different abnormal events depicts that the decreasing rate of breakdown is very less as compared to traditional method.

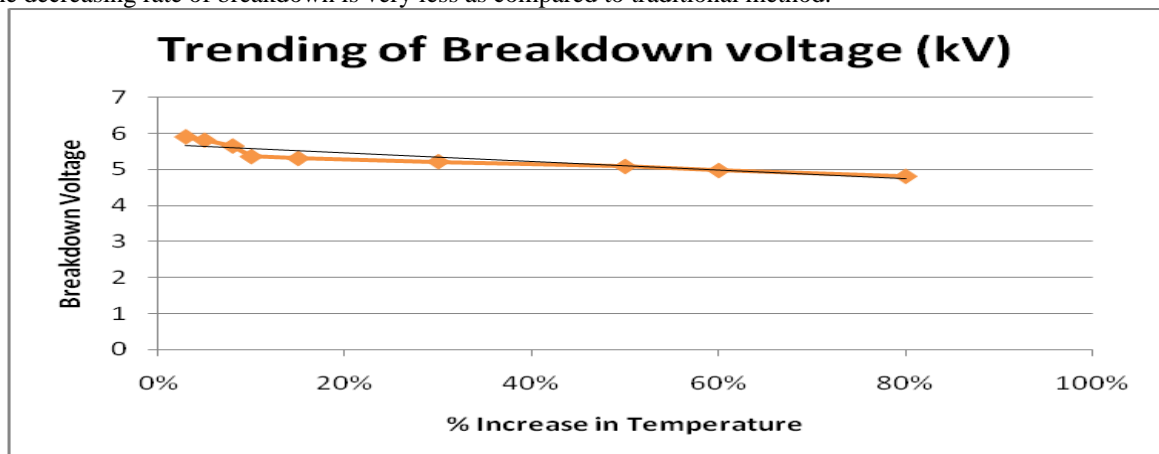


Fig. 4.10 Breakdown Voltage of Oil with Intelligent Technique

## CONCLUSION

The developed artificial intelligence-based technique reduced the formation of oxidative products by 18% in comparison to conventional technique during various critical events like single-phase faults, three-phase faults, uneven power electronic loading and capacitive switching transient conditions. This reduction of oxidative products results in reduced formation of acid & sludge which outcomes in increased operational reliability of transformer and power system.

## REFERENCES

- [1] R. Soni, P. Chakrabarti, Z. Leonowicz, M. Jasiński, K. Wieczorek and V. Bolshev, "Estimation of Life Cycle of Distribution Transformer in Context to Furan Content Formation, Pollution Index, and Dielectric Strength," in *IEEE Access*, vol. 9, pp. 37456-37465, 2021, doi: 10.1109/ACCESS.2021.3063551.
- [2] Prevost, T.A.; Oommen, T.V. Cellulose insulation in oil-filled power transformers: Part I—History and development. *IEEE Electr. Insul. Mag.* 2006, 22, 28–35.
- [3] Rouse, T.O. Mineral insulating oil in transformers. *IEEE Mag. Electr. Insul. Mag.* 1998, 14, 6–16.
- [4] *Electrical Power Equipment Maintenance and Testing*, Second Edition, Paul Gill
- [5] R. Madavan and S. Balaraman, "Failure analysis of transformer liquid—Solid insulation system under selective environmental conditions using Weibull statistics method", *Eng. Failure Anal.*, vol. 65, pp. 26-38, Jul. 2016.
- [6] H. Pezeshki, P. J. Wolfs and G. Ledwich, "Impact of high PV penetration on distribution transformer insulation life", *IEEE Trans. Power Del.*, 2014, 29,1212-1220.
- [7] S. Karmakar, A. Dutta and H. Kalathiripi, "Investigation of the effect of high voltage impulse stress on transformer oil by infrared spectroscopy", *Proc. Int. Conf. High Voltage Eng. Technol. (ICHVET)*, Feb. 2019, pp. 1-5.
- [8] R. Godina, E. Rodrigues, J. Matias and J. Catalão, "Effect of loads and other key factors on oil-transformer ageing: Sustainability benefits and challenges", *Energies*, 2015, 8,12147-12186
- [9] Sharin Ab Ghani, Nor Asiah Muhamad, Zulkarnain Ahmad Noorden, Hidayat Zainuddin, Norazhar Abu Bakar, Mohd Aizam Talib, Methods for improving the workability of natural ester insulating oils in power transformer applications: A review, *Electric Power Systems Research*, Volume 163, Part B, 2018, Pages 655-667, ISSN 0378-7796, <https://doi.org/10.1016/j.epsr.2017.10.008>.
- [10] R. M. Arias Velásquez and J. V. Mejía Lara, "Corrosive sulphur effect in power and distribution transformers failures and treatments", *Eng. Failure Anal.*, 2018, 92, 240-267.
- [11] Chera Anghel, I. A. and Gatman, E., "Transformer lifetime management by analyzing the content of furan and gas dissolved in oil", in *E3S Web of Conferences*, 2019, vol. 112. doi:10.1051/e3sconf/201911204004.
- [12] S. Forouhari and A. Abu-Siada, "Application of adaptive neuro fuzzy inference system to support power transformer life estimation and asset management decision", *IEEE Trans. Dielectrics Electr. Insul.*, 2018, 25, 845-852.
- [13] L. Wanninayaka, C. Edirisinghe, S. Fernando and J. R. Lucas, "A mathematical model to determine the temperature distribution of a distribution transformer", *Proc. Moratuwa Eng. Res. Conf. (MERCon)*, Jul. 2019, pp. 462-467.
- [14] J. Sun, S. Zhang, Z. Xu, C. Wu, X. Yu, Y. Qiu, et al., "Oil-paper insulation characteristic and maintenance measures of oil-immersed transformer in cold environment", *Proc. IEEE 19th Int. Conf. Dielectric Liquids (ICDL)*, Jun. 2017, pp. 1-5.
- [15] R. A. Abd El-Aal, K. Helal, A. M. M. Hassan and S. S. Dessouky, "Prediction of transformers conditions and lifetime using furan compounds analysis", *IEEE Access*, 2019, 7,102264-102273.
- [16] M. T. Rathna, R. V. Maheswari and P. S. Pakkianathan, "Enhancing the properties of used mineral oil by regeneration process," 2017 Third International Conference on Advances in Electrical, Electronics, Information, Communication and Bio-Informatics (AEEICB), 2017, pp. 311-315, doi: 10.1109/AEEICB.2017.79723.
- [17] M. Rafiq, L. Chengrong and Y. Lv, " Effect of Al<sub>2</sub>O<sub>3</sub> nanorods on dielectric strength of aged transformer oil/paper insulation system ", *J. Mol. Liquids*, 2019, 284,700-708.
- [18] IEEE, C57.637-2015 (Revision IEEE Standard 637-1985), "IEEE Guide for the Reclamation of Mineral Insulating Oil and Criteria for Its Use", 2015, 1-38.