

SMART SECURITY SYSTEM FOR TWO-WHEELERS

Niyati Rana¹, Pravesh Khatta², Antim Dev Mishra³

E-Mail Id: ¹niyatirana.btech17@ansaluniversity.edu.in, ²praveshkhatta.btech17@ansaluniversity.edu.in, ³antimdevmishra@ansaluniversity.edu.in

School of Engineering and Technology, Sushant University, Gurugram, Haryana, India

Abstract- Internet of things enables us to share data over large or small scalable networks, that consist of inter-related computing devices, sometimes referred to as nodes of the network, without the interference of humans or other machines. Because of the effortless communication between IoT devices, IoT is prevalently used in Security Systems. Two-Wheelers are the preferred vehicle to steal due to the ease with which they are dismantled and Two-wheeler thefts are at a rapid rise in India, whereas the rate of recovery remains horribly low, leading to a huge loss that can be considered unrecoverable. A survey of the presently available security measures and systems was carried out. The objective of the investigation was to understand the security measures that are needed to be taken, as well as the current availability of the same in the market. Following this, a system was designed and developed using IoT components to create a smart security system that is effective, as well as affordable.

Keywords: Security System, Two Wheelers, Recovery, Theft Avoidance.

1. INTRODUCTION

IoT refers to a network of devices that make the network self- configuring. The development of Intelligent Smart Security IoT based devices is day by day turning the face of the security systems industry by not only enhancing it but also making it cost-effective. [12]

The purpose / objective of this report is to provide two wheelers with an IoT-based Smart Security System to help people protect their vehicles.

The proposed IoT-based Smart Protection System is combined with Arduino Technology mixed with a fingerprint sensor and a GSM module that allows the vehicle to be remotely turned on and monitored in real time.

2. OVERVIEW

The objective of this report is to propose IoT based Smart Security System for Two Wheelers which will work by providing vehicle owners an extra layer of protection for their vehicles, at a very low cost.

2.1 IoT Concept and Definition

The term "Internet of Things" refers to different IOT devices with individual uniqueness and their ability to perform remote sensing, actuation and live surveillance of certain kinds of data. IOT devices also enable live information sharing with other connected applications and devices, either actively or passively, or data from several other devices to be collected and processed and relayed to different servers. The second word internet is known as a Global

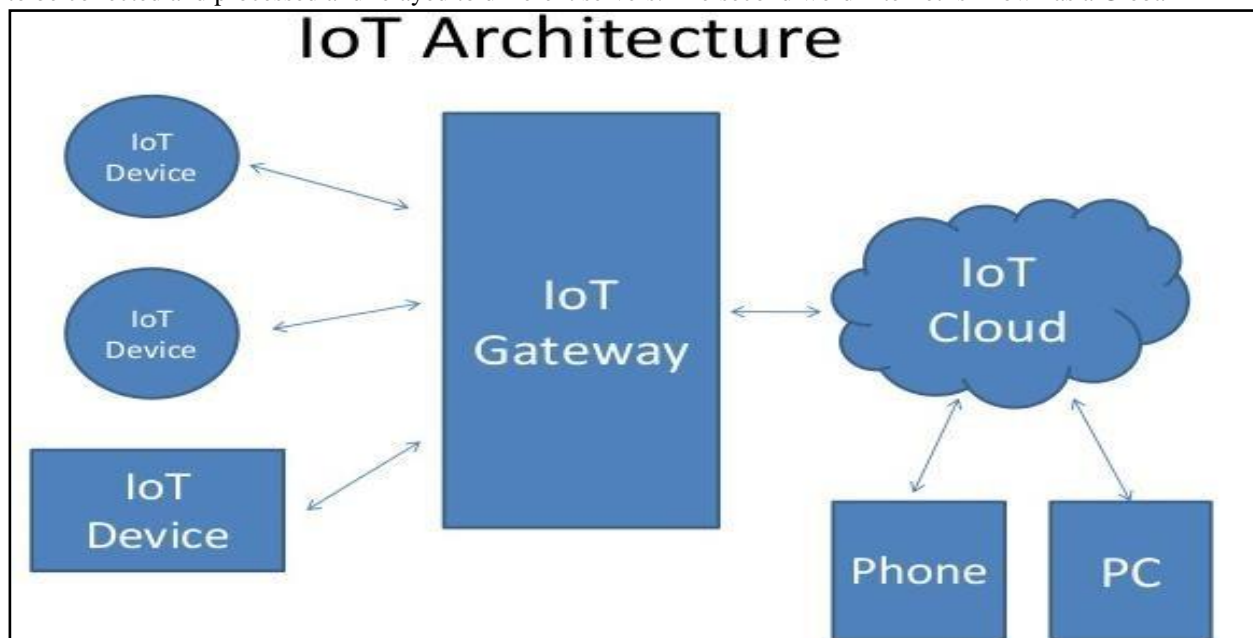

Fig. 2.1 IoT Architecture

Communication Network that connects trillions of computers across the globe to allow information sharing. Thus, the IOT can be defined as:

“A dynamic Global Network Infrastructure with self-configuring capabilities based on standard and inter operable communication to protocol where physical and virtual things have identities, physical attributes, and virtual personalities and use intelligent interfaces and are seamlessly integrated into the information network, often communicate data associated with user and their environment.” [12]

An optimal IoT system consists of multiple interfaces and applications to connect and communicate to other devices/gadgets and can be either wired or wireless.

Any IoT based system consists of following components:

- I/O Interface for Sensors
- Interface for Memory and Storage.
- Interface for Audio/Video.
- Interface for connecting to Internet.

IoT devices can be of many different shapes, such as wearable sensors, smart watches, IoT smart home monitoring, IoT smart transport systems, IoT smart health devices etc.

2.2 IoT Enabling Technologies

2.2.1 Wireless Sensor Network (WSN)

It consists of different sensors / nodes that are fused or integrated together to track different kinds of data.

2.2.2 Cloud Computing

Cloud computing, also known as on- demand computing, is a form of internet-based computing that provides computers and other devices with shared processing resources and data upon demand. It may be in various shapes, such as IaaS, PaaS, SaaS, DaaS etc.

Since the word "cloud" is often used as an Internet metaphor, "cloud computing" refers to being able to obtain computational power via the world wide web instead of traditional systems where computing equipment is physically present at the user's premises and any software applications are installed on such local hardware. Cloud computing is defined as:

“A model for enabling ubiquitous, convenient, on-demand network access to a shared pool of configurable computing resources (e.g., networks, servers, storage, applications, and services) that can be rapidly provisioned and released with minimal management effort or service provider interaction.” [13]

Cloud computing and its 3 distinct service models–Software as a Service (SaaS), Platform as a Service (PaaS) and Infrastructure as a Service (IaaS) –are relevant to IoT because they enable any user with a browser and an internet access to turn smart object information into usable knowledge. In other words, cloud computing offers "the virtual utility computing infrastructure that incorporates applications, monitoring devices, storage devices, analytics tools, visualization platforms, and consumer delivery... [to] enable individuals and companies to reach [IoT-enabled] applications on demand at anytime, anywhere, anywhere." [14] [15]

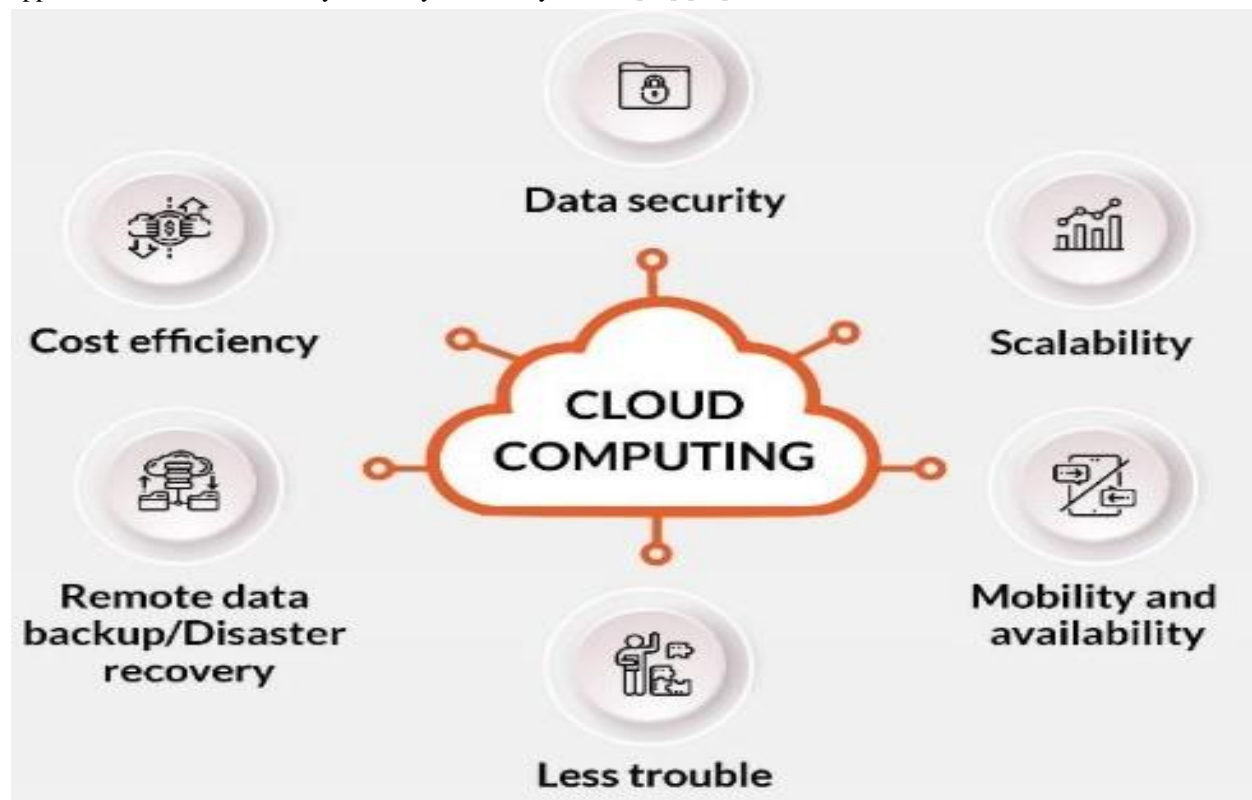

Fig. 2.2 IoT Applications in Cloud Computing

BIG DATA & ANALYTICS



Fig. 2.3 IoT Applications in Big Data and Analytics

Big Data—to unmask hidden pattern, unknown correlations, market trends, desires of consumers and other useful business information. As more intelligent devices (smart objects) are connected to the Internet of Things, more information is gathered from them in order to conduct analytics to identify patterns and affiliations that results in insights.

Thus, the term "big data" refers to certain large sets of data that would need to be processed, preserved, enquired, evaluated and generally handled in order to deliver on the IoT pledge.

Furthermore, the technological challenges of big data are compounded by the fact that IoT systems must tackle not only the data obtained from intelligent devices but also the spatial information required to conduct such analytics properly (e.g., weather- related public and private data sets, GIS, political, seismic, map, GPS, crime etc.).

Thus, with more connected devices coming online, IoT operators usually use at least three measures to characterize the big data they handle: quantity, speed and variety. [13]

2.2.3 Communication Protocols

They serve as the foundation of IoT networks to allow communication and access to applications, and these protocols promote the sharing of data over the network, since these protocols support information exchange formats, data encoding and addressing.

2.2.4 Embedded Systems

It involves microprocessor / microcontroller, RAM / ROM, networking components, I / O systems and storage devices.

3. IoT IN SECURITY SYSTEMS

The protection and surveillance industry is evolving and technologies have gone well beyond traditional monitoring of alarms.

The Internet of Things (IoT) aims to build safer communities, households, and businesses by offering smart protection and surveillance solutions for both private and public agencies to track facilities and public spaces safely and remotely in real-time.

By harnessing IoT power and authority for your protection and surveillance solutions, you empower owners of buildings, managers of organizations and security professionals to:

- Manage and manage remote monitoring systems to monitor all aspects of an installation;
- Make better choices on the best course of action to be taken based on real-time security.
- Determine whether there is a false alarm without having to personally check the position or deploy police officers in an inappropriate manner.
- Perhaps the biggest advantage of using IoT systems for your protection system is the ability to prevent loss of sensitive asset
- Achieve greater accessibility over who reaches the facility and leaves it in real time
- Quickly act on critical security warnings sent directly to your mobile device
- Track the facilities conditions reliably and safely from any location with Wi-Fi access

IoT helps you to gain greater control over your properties to enhance safety and avoid critical losses by real-time monitoring. IoT offers integrated wireless security monitoring solutions for security providers, property managers,

public agencies and communities looking to develop efficient and secure security systems.

As the industry is increasingly moving towards new, more systematic tools and techniques for managing organizational security, we are changing the way we handle both digital and physical security threats.

Once institutional frameworks have congregated to enable an efficient, top-down laws regarding and the requisite technical resources have been made accessible, standard industry toolchains, enforcement and regulations need to be strengthened to allow for complete operational convergence. It would ensure that we are functionally aligned and ready to enforce the integration plan. [6]

4. LITERATURE SURVEY

With traffic jams on the rise, two-wheelers are also the preferred mode of transport for many Indian people today. There is much less risk of being trapped in congested roads while you're on a bike. Another main explanation why two-wheelers are common among the as such- called lower class, and perhaps even the upper middle class, is their affordability factor.

For several, bikes are a much more transportable alternative compared to cars. Superbike fans have started buying expensive bikes, as more and more world-famous companies have set up shops in the region. [11] A bike has a greater risk of being stolen than a car. In comparison, retrieving stolen cars seems to be a more streamlined operation than detecting stolen two-wheelers. The explanation for this is clear. It's easier to disassemble and conceal the two-wheeler. Making comments on the numbers, former Delhi Police Commissioner Amulya Patnaik notified The Hindu that the pattern over the last few years has been a good rate of identification under the head of the perpetrator,

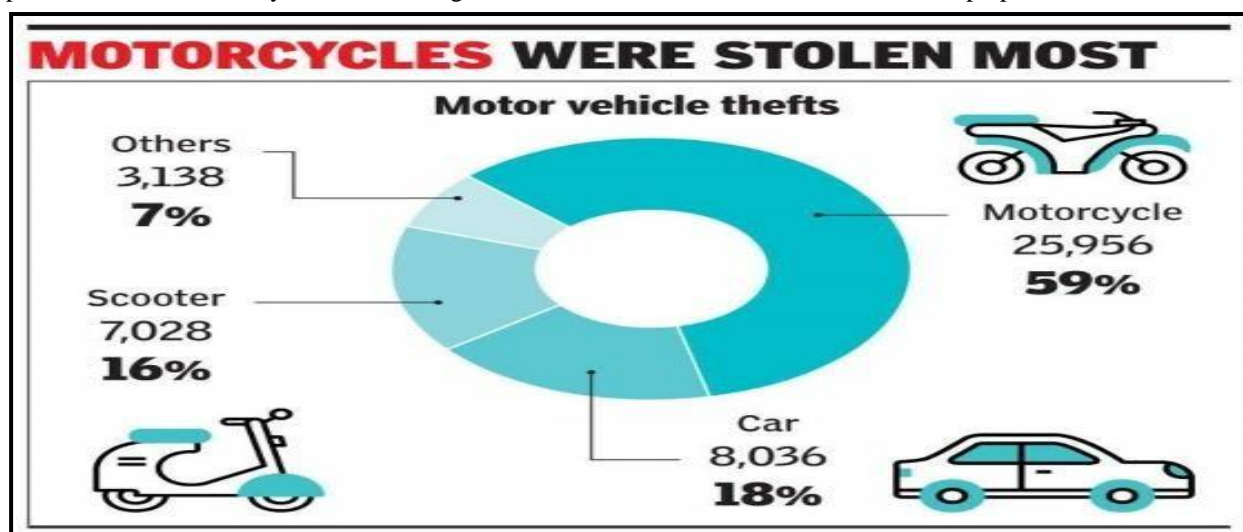

Fig. 4.1 Vehicle Theft Report Pie Chart

as it is not a perpetrator that can be tracked to the criminal. "It is one of the difficult crimes to investigate and is mostly solved when gangs of auto lifters are busted and then linked with their previous involvement," he said. [11]

The police have said that most incidents of motor vehicle theft involve two-wheelers, and the crime analysis indicates that these vehicles are stored in unguarded and badly lit areas.

In 2018, the police announced that of the 44,158 stolen cars, 32,984 were two-wheelers and 8,036 were cars. Even then, only 10.46 per cent of the cars were retrieved, while 6,751 car lifters were detained. [11]

Furthermore, in 2014, A Times of India announced that a vehicle had been stolen every 15 minutes in New Delhi. The number of retrieved vehicles has further decreased by 13 per cent, as disclosed by the Delhi Police Department. The primary reason for robbery was a significant shortage of parking area. Gurgaon had robbed 3,240 vehicles in 2014, of which 2,580 were bicycles and scooters. [11]

The amount of bike thefts is very high, while the rate of revival remains low at 20 to 25 per cent. Any form of harm or damage wrought to the two-wheeler can have an effect on the entire monthly family fiscal program. It could get worse if the bike is stolen. There's no question that the battle for the best two-wheeler protection device is at the top of the minds of many Indians. [11]

5. PROJECT DESCRIPTION

5.1 Definition: IoT Based Smart Security System for Two Wheelers

IoT based SMART SECURITY SYSTEM FOR TWO WHEELERS is regarded as an IoT gadget focusing on securing two-wheeler vehicles against thefts, as well as increasing the probability of recovery of two-wheeler vehicles after they have been stolen.

The system enables the owner of the vehicle to start the engine of the vehicle only by scanning his fingerprint i.e. nobody else can start the bike, even if they have the key (Possessing the key will only let one turn on the battery, but to turn on the engine, the right fingerprint has to be scanned.)

If a thief tries to steal the vehicle by by-passing the entire process of putting in the key and scanning their fingerprint, and instead, just rubs the battery wire against the engine's spark plug, in order to start the vehicle, the owner of the bike will receive a message on their phone letting them know that somebody is tampering with their vehicle and a

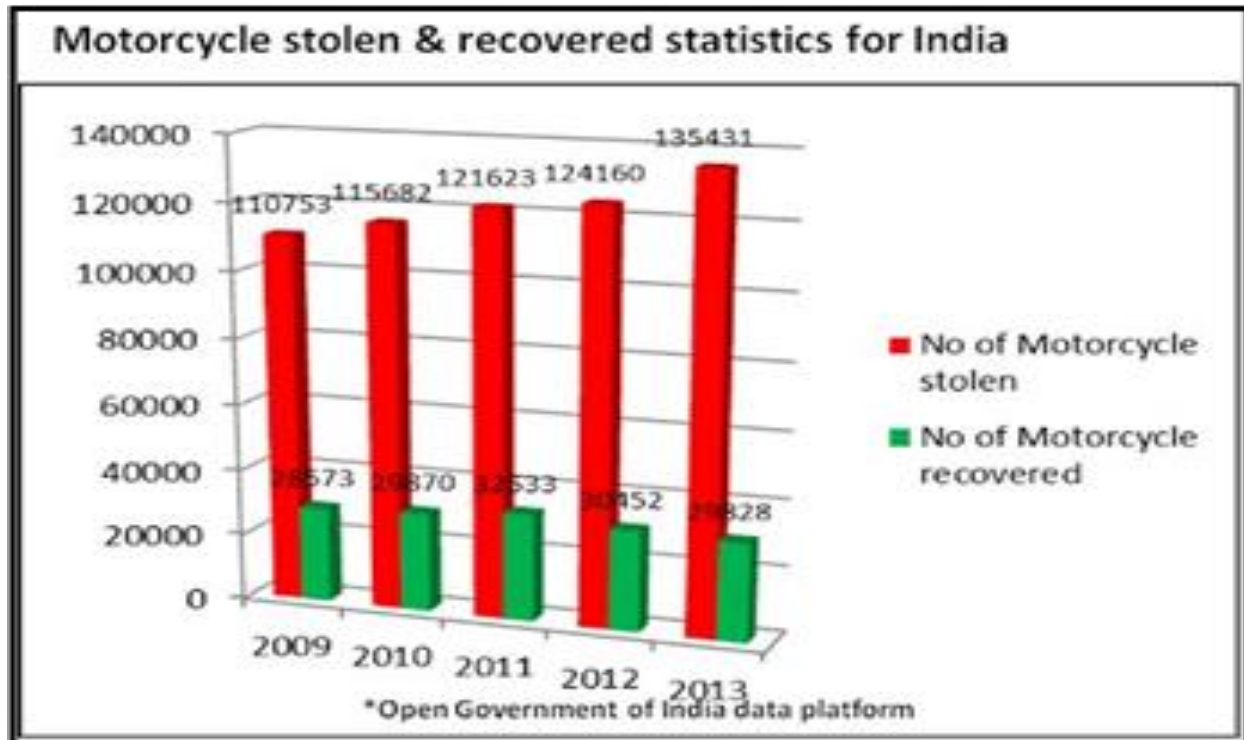

Fig. 5.1 Motorcycle Stolen and Recovered Statistics in India

buzzer will start to go off until the owner stops it from their app. Also, as we have used a GSM shield, Arduino is always connected to the internet, as a result of which, the owner can easily track their vehicle.

In case the owner decides to lend their vehicle to someone, they can just turn off the fingerprint sensor from their phone. Upon doing this, the fingerprint sensor input will automatically be set to TRUE and the bike will start automatically i.e. the owner can start their vehicle REMOTELY from their phone. The user of the vehicle will just have to turn on the vehicle's battery with the key and then the owner can turn the engine ON remotely through their phone.

5.2 Components and Modules

5.2.1 Arduino Mega

The Arduino board is an open-source microcontroller board built upon the Atmega 2560 microcontroller. The computing or wiring language is carried out in the growing setting of this board. Such boards have replenished the automation industry with their easy-to-use platform wherever anyone with a low or technical background can start by exploring some of the skills required for the system as well as running the Arduino board. Such boards are used to expand different interactive objects, then we will connect to applications on your PC such as MaxMSP, Processing, and Flash. [1]

The microcontroller board like "Arduino Mega" is based on the ATmega2560 microcontroller. It includes digital input/output pins-54, where 16 pins are analog inputs, 14 are used as PWM output hardware serial ports (UARTs)-4, a crystal oscillator-16 MHz, an ICSP header, a power jack, a USB connection, and a RST button. This board contains, in particular, all that is necessary to support the microcontroller.

The power source of this board can be made by connecting it to a PC using a USB cable, a battery or perhaps an AC-DC adapter. This board can also be secured from accidental electrical discharge by adding a base plate. [1]

5.2.2 Arduino Mega Specifications

- Microcontroller
- Operating voltage - 5volts
- Input Voltage - 7volts to 12volts
- Digital input/output pins - 54 where
- PWM pins - 15
- Analog Input Pins - 16
- DC Current - 40 mA
- DC Current - 50 mA
- Static random access memory (SRAM) - 8KB

- Electrically erasable programmable read- only memory (EEPROM) - 4 KB
- Clock (CLK) speed - 16 MHz
- USB host chip -
- MAX3421E
- Length - 101.52 mm
- Width - 53.3 mm
- Weight – 36

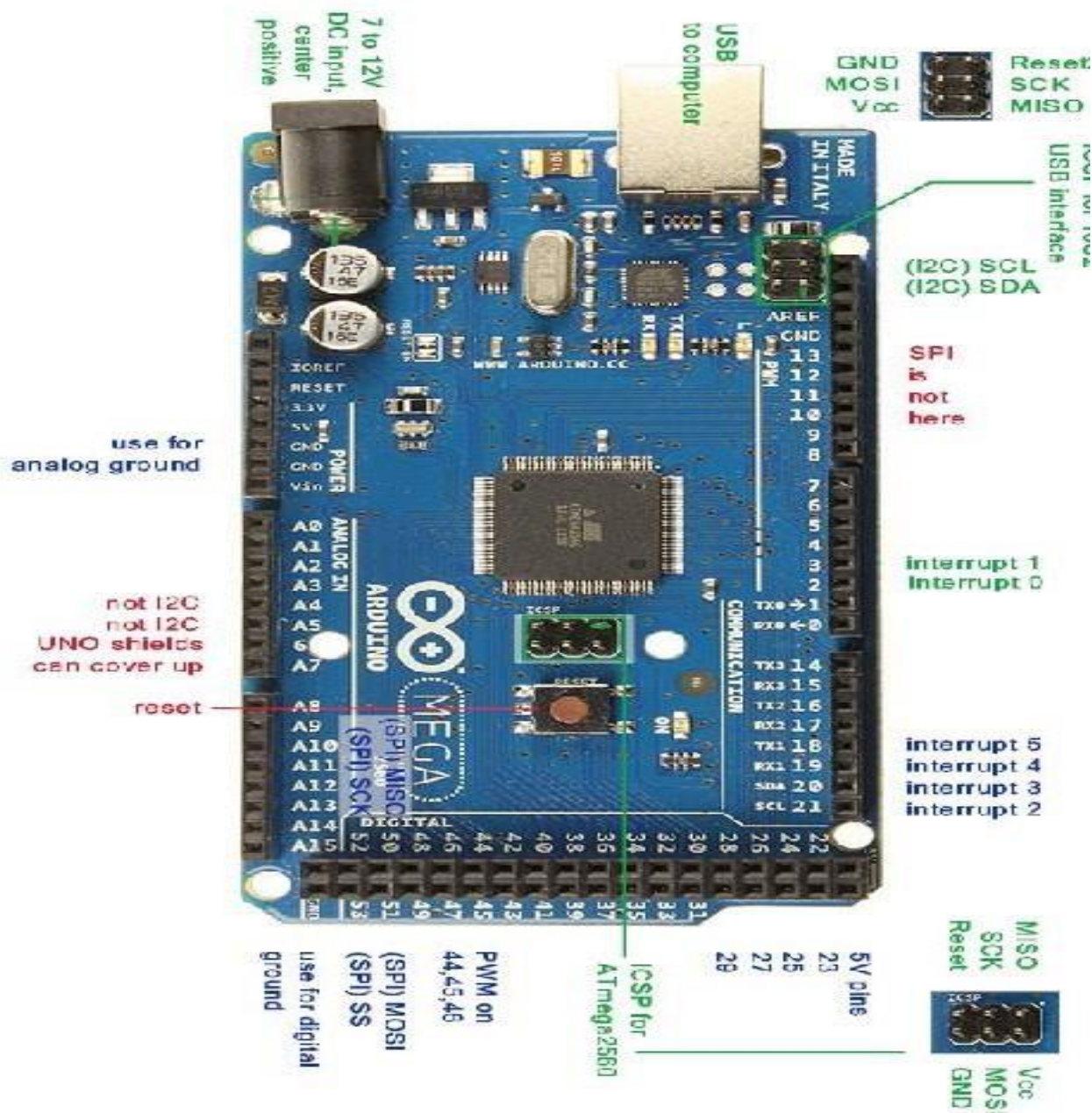

Fig. 5.1 Arduino Mega Pin Specification Diagram

Table-5.1 ATmega 2560 Technical Specifications

Microcontroller	ATmega 2560
Operating Voltage	5V
Output Voltage (recommended)	7-12V
Input Voltage (limit)	6-20V

Digital I/O Pins	54(of which 15 provide PWM output)
Analog Input Pins	16

DC Current per I/O Pin	20mA
DC Current for 3.3 V Pin	50mA
Flash Memory	256 KB (8 KB used by bootloader)
SRAM	8KB
EEPROM	4KB
Clock Speed	16MHz
LED_BUILTIN	13
Length	101.52
Width	53.3mm

5.2.3 Arduino MEGA Pin Specification

5.2.3.1 Pin 3.3V and 5V

These pins are used to supply a controlled o / p voltage of approximately 5V. This RPS provides power to the microcontroller as well as to other components used on the Arduino mega board. It can be achieved with the Vin- pin of the board, while 3.3V0- pin can be provided with another voltage regulation. The maximum power that can be drawn is 50mA.

5.2.3.2 RST Pin

The RST pin can be used to rearrange the board. By setting this pin to low, the board can be readjusted.

5.2.3.3 Vin Pin

The amount of input voltage delivered to the board varies from 7 volts to 20 volts. We can access the power provided by the power jack through this pin. However, the output voltage of this pin to the board will be set to 5V automatically.

5.2.3.4 Serial Communication

TXD and RXD are used to transmit and receive serial data. Tx implies the transfer of the information while the RX indicates the reception of the data. The serial pins on this board have four combinations. Serial 0 includes Tx (1) and Rx (0), serial 1 includes Tx(18) and Rx(19), serial 2 includes Tx(16) and Rx(17), and serial 3 includes Tx(14) and Rx(15).

5.2.3.5 Analog Pins

The board has 16 analog pins, marked as A0- A15. It is very critical to note that all analog pins on this board can be used as digital I / O pins. Each analog pin is available with a 10-bit resolution that can be calculated from GND to 5 volts.

5.2.3.6 Shield Compatibility

Arduino Mega is well matched to most of the guards used in other Arduino boards. Before you plan to use a guard, check that the operating voltage of the guard is well matched to the voltage of the guard. The working voltage of most of the guards is 3.3V otherwise 5V. But, guards with a high operating voltage can be harmful to the wall. In addition, the shield distribution header will vibrate with the Arduino board distribution pin. To do this, you can simply attach the shield to the Arduino board and make it in a running state.

5.2.3.7 Programming

The programming of the Arduino Mega 2560 can be performed by means of the IDE (Arduino Software) and supports the C- programming language. Here the sketch is the code in the software that is burned inside the software and then shifted to the Arduino board using a USB cable.

5.3 SIM800L GPRS GSM Module

The SIM800L GSM / GPRS module is a mini GSM modem which can be built into a wide variety of IoT projects. It

could be used to achieve almost anything that a mobile phone can do; send and receive SMS text messages, make or receive phone calls, connect to the internet via GPRS, TCP / IP, etc. The module supports a quad-band GSM/GPRS network and works pretty much anywhere in the world.

The first is made of wire (which solders directly to the NET pin on the PCB) – very useful in narrow areas. Second – PCB antenna – with double-sided tape and a pigtail cable connected to the IPX connector. That one has better efficiency and allows you to place your module inside a metal frame.



Fig. 5.2 SIM800L GPRS GSM Module

5.3.1 Siren/Buzzer

The Active Alarm Buzzer Module for Arduino is an audio signaling device which can be either mechanical, electromechanical or piezoelectric. This is the DC Electronic Component Active Buzzer Module. An active buzzer rings out as long as it's electrified. Compared to a passive buzzer, it's a bit expensive but easier to control. Common applications of buzzers include alarms, timers, and input data confirmation, like a mouse click or keystroke.

5.3.2 Relay Switch

The Single Channel Relay Module is a suitable board that can be used to control high voltage, high current loads such as motors, solenoid valves, lamps and AC loads. It is designed to interface with microcontrollers like the Arduino, PIC, etc. The terminal relays (COM, NO and NC) are replaced with the screw switch. It also comes with an LED to indicate the relay status.

5.3.3 Fingerprint Sensor

GTM- 5210F12 is a biometric authentication module which utilizes the ARM Cortex M3 Core (Holtek HT32F22366) to support the UART communication interface. It has fast, easy and high definition (450DPI) fingerprint registration, 1:1 fingerprint authentication, 1: N fingerprint authentication. Features of Fingerprint Sensor:

- Storage for 200 unique fingerprints
- Wake up on Finger Function
- Works well with dry, moist or rough fingerprints
- Anti-scratch with surface high hardness $\geq 5H$
- 1:1 verification, 1:N
- High-accuracy and high-speed fingerprint identification technology

5.3.4 Power Source (9V Battery Cell)

The most popular type of nine-volt battery is generally referred to as a transistor battery. It has a rectangular shape with rounded edges and a polarized snap connector at the top. This type is commonly used for pocket radios and other small electronic devices. They are often used as backup power to hold time in some electronic clocks. This battery can be used as a power source.



Fig. 5.3 A 9V Battery Cell

5.3.5 Neo-6M GPS Module

NEO- 6 M Global Positioning System (GPS) module, a quite famous, affordable, high-performance GPS module with a ceramic patch antenna, an on-board memory chip and a backup battery that can be easily incorporated with a diverse variety of microcontrollers.

Table-5.2 Neo 6M GPS Module Pin Connections

NEO 6M GPS MODULE	USB-to-SERIAL CONVERTER
TX	RX
RX	TX
GND	GND
VCC	5V

5.3.6 Bread Board and Connecting Wires

The breadboard is used to construct and test circuits quickly in order to finalize any circuit design. The breadboard has many openings in which route components such as ICs and resistors can be connected. In general, the openings are spaced 0.1" apart to set up standard DIP machines. Jump wires are generally used to connect to the breadboard.

6. PROPOSED WORKING MODEL

First, we will need a breadboard to connect the microcontroller, fingerprint sensor, buzzer, GPS Module and the SIM800L GSM/GPRS module using the connecting wires. The breadboard is used to interface between the various components available. It also makes it easy to connect multiple inputs to a single pin on the Arduino board.

Following sketch, which has been constructed using an online software shows how the components are supposed to be connected together using the breadboard and the jumper wires. The final configuration need not be identical to the

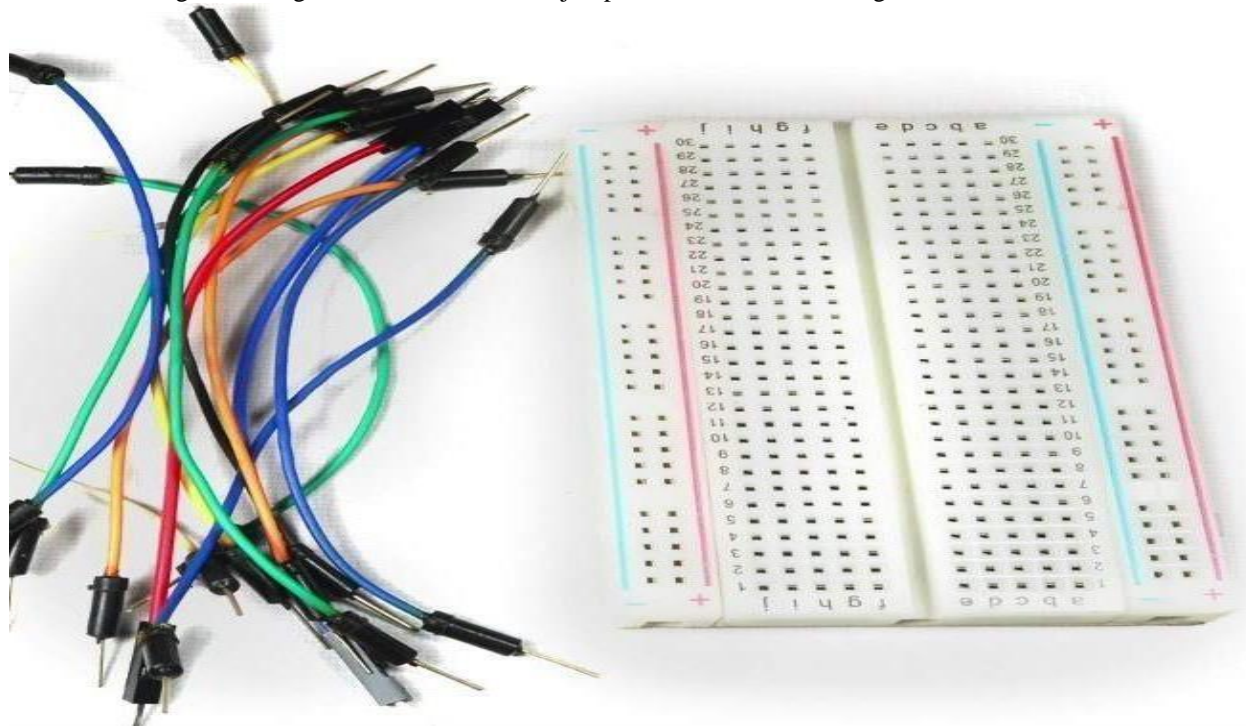

Fig. 6.1 Bread Board and Connecting Wires

given sketch, although the pins on each device needs to be connected to the same corresponding pins on the Arduino Uno board.

In this circuit there is a programmed ARDUINO which is connected with fingerprint sensor and a GSM module. The working principal of the model is based on monitoring the vehicle with the help of ARDUINO and if the Engine is started without scanning the fingerprint, passing an alert to the GSM module. The GSM module gives the updates to the owner's device through mobile network. There is a 9V battery cell for the fingerprint sensor, as the sensor cannot withstand the high voltage from the vehicle's battery (which is connected to Arduino board).

7. CIRCUIT DIAGRAM

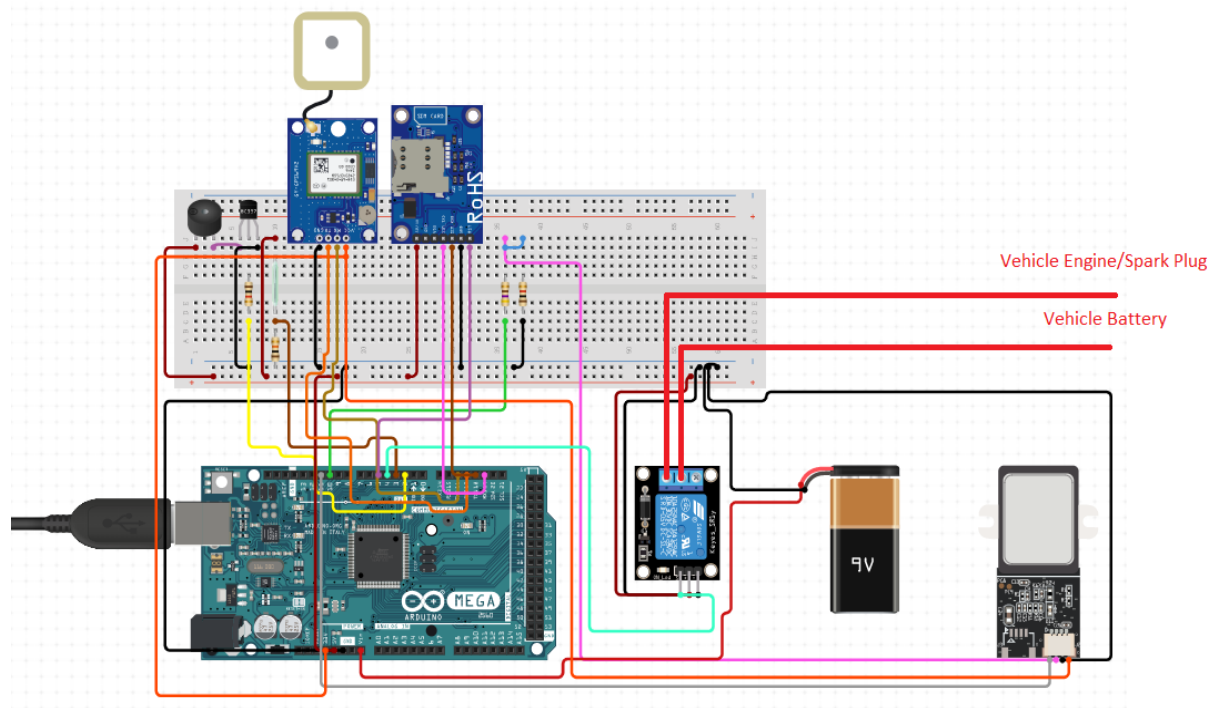

Fig. 7.1 Circuit Diagram for the Two-Wheeler Security System

8. FLOWCHART

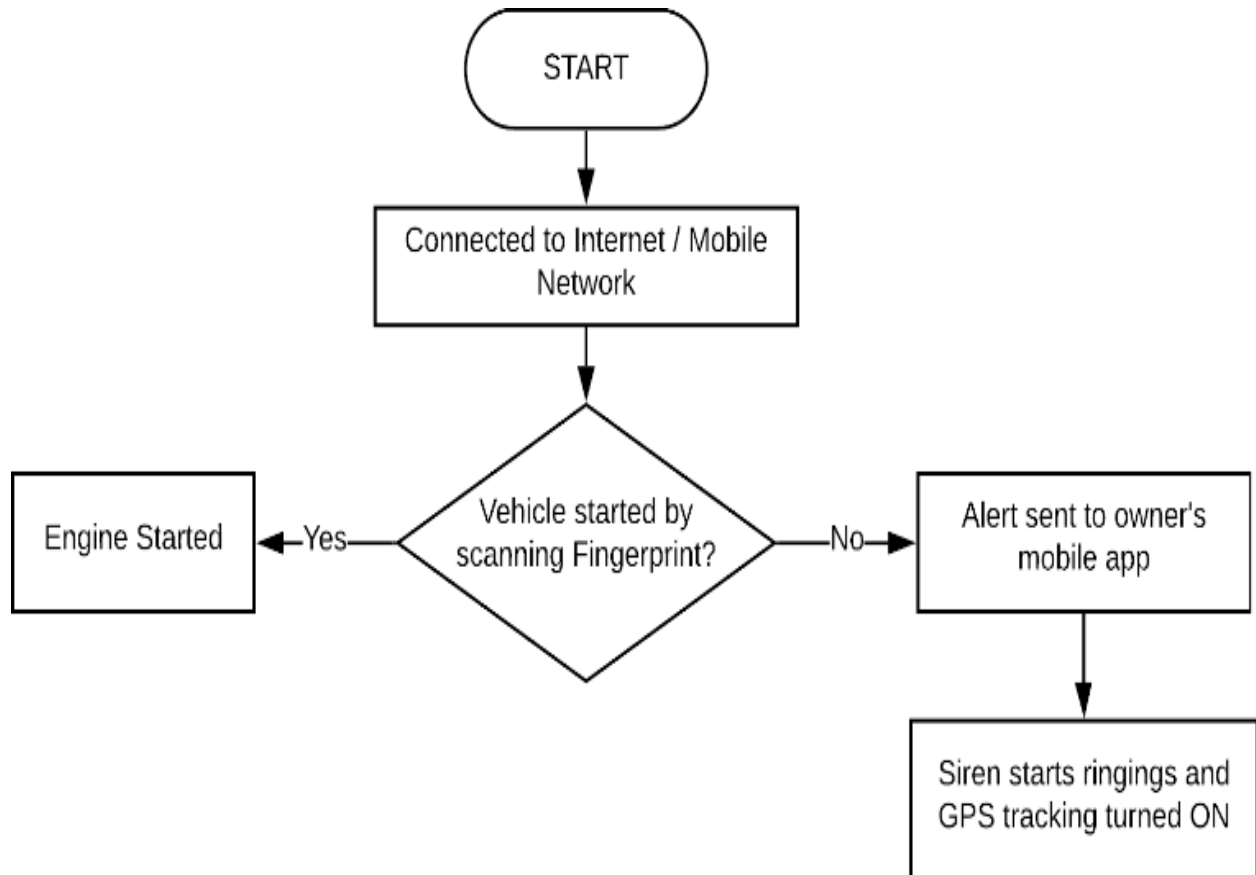

Fig. 8.1 Flowchart Showing the Working of the Proposed Two-Wheeler Security System

CONCLUSIONS

IoT based Smart Security System for making the two-wheeler vehicles more secure and increasing the rate of recovery after theft has been proposed using Arduino and Internet/Mobile Network. The System has high efficiency and

accuracy in recognizing the rightful owner and deciding if a theft is taking place. The IoT based smart security System being proposed via this report will assist two-wheeler vehicle owners in increasing the security for their vehicles and take efficient safety precautions and minimal cost with more than 99% accurate results.

Future work would be focused on making the vehicle more secure by developing a special type of circuit that will involve a fuse which can stop the current from flowing through the battery to the spark plug, if a thief tries to start the vehicle directly.

REFERENCES

- [1] Simon Monk, Programming Arduino: Getting Started with Sketches, 2nd Edition, McGraw-Hill Education, 2011
- [2] Simon Monk, Programming Arduino Next Steps: Going Further with Sketches, McGraw-Hill Education, 2013
- [3] Nitin Kumar, Jatin Aggarwal, Chavi Sachdeva, Prerna Sharma, Monica Gaur, “Smart Bike Security System”, International Journal of Education and Science Research Review, 2015
- [4] L.Wan and T.chen, “Automobile Anti-theft Sytem Design Based on GSM”, Proceeding of IEEE on Advanced Computer Control, 2009, pp.551-554.
- [5] Muhammad Ali Mazidi, Janice Gillispie, Rolin McKinlay, The 8051 Microcontroller and Embedded systems, Pearson Publications, 2nd Edition, 2006.
- [6] RuchitaJ.SHah and Anuradha P. Gharge, “GSM Based Car Security System”, International Journal of Engineering and Innovative Technology (IJEIT,) Volume 2, Issue 4, October 2012.
- [7] K. A. Amusa, O. O. Nuga and A. A. Adetomi, “Design of SMS enabled car security system”, Transnational Journal of Science and Technology, Edition Vol.2, November 2012.
- [8] Shweta K. Narkhede, Bharat P. Tanwani, Vivek P. Borse, Asst. Professor Ishwar S. Jadhav, Mr. Milind D. Dhanke, “Two-Wheeler Security System”, International Research Journal of Engineering and Technology (IRJET), 2017
- [9] Hernando Barragán, “The Untold History of Arduino”, 2016
- [10] Alan G. Smith, Introduction to Arduino, 2016
- [11] Hemani Bhandari, “Police data show motor vehicle theft the least-solved crime”, The Hindu, 2019
- [12] Cuno Pfister, Getting Started with the Internet of Things, 1st Edition, O'Reilly Media, 2011
- [13] Giacomo Veneri, Antonio Capasso, Hands-On Industrial Internet of Things, Packt Publishing, 2018
- [14] Surjit Singh, Handbook of Research on the IoT, Cloud Computing, and Wireless Network Optimization (Advances in Wireless Technologies and Telecommunication), 1st Edition, IGI Global, 2019
- [15] Farshad Firouzi, Intelligent Internet of Things: From Device to Fog and Cloud, Springer, 2020